



PRESSURE TRANSMITTERS

3000 PRESSURE TRANSMITTER MODEL:3000



Features & Benefits

- Stainless steel wetted parts
- Excellent resistance to corrosive
- Small figure design, any position to install Various signal output
- OEM process to fit application of the customers

Descriptions

3000 Series industrial pressure transmitter adopt high performance chips, and deal with the special amplified chip, integrative configuration, and smart profile,

they are widely used in the field of hydraulic pressure, medicament and sanitation, constant pressure water supply system and so on.

Specifications

Ranges: -100KPa 0KPa 2500bar

Combined error: =0.25%FS; =0.5%FS, 1.0%FS

Output: 4 20mA, 0 20mA, 0 5V, 0 10V

Input voltage: 24Vdc (10 36Vdc)

Operating temperature: -40°C 125°C

Over pressure: 1.5•FS



Electric connection: M12 connector, five Pin
bended connector,

Hirschman and direct down-lead

Process connection: G1/4, M20•1.5,
1/4NPT (Customized)

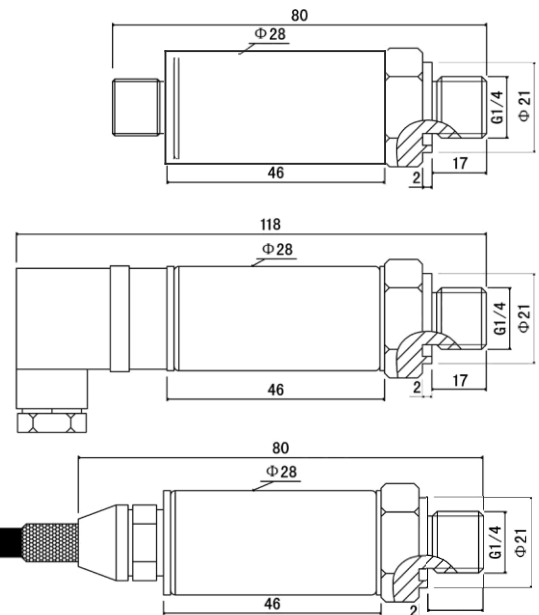
Dimensions:

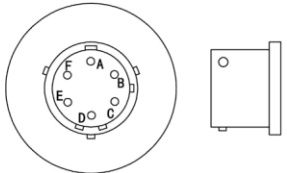
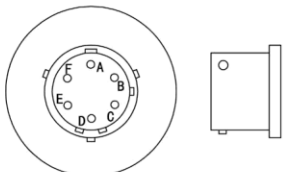

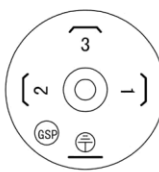
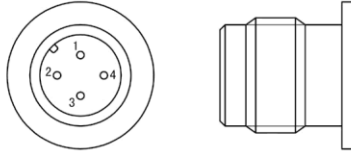
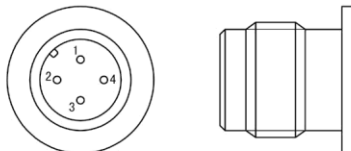
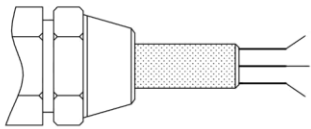
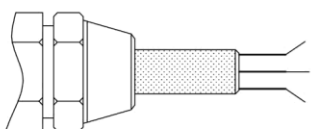
Models	Lead	Color	6PIN	
Output: 0-5V; 0-10V 3000 Series	Signal +	Blue	A	
	Signal -	Green	B	
	Excitation +	Red	C	
	Excitation -	Yellow	D	
Models	Lead	Color	6PIN	
Output: 4-20mA 3000 Series	Excitation +/ Signal +	Red	A	
	Excitation -/ Signal -	Black	B	
Models	Lead	Color	4PIN	
Output: 0-5V; 0-10V DIN43650 3000 Series	Excitation +	Red	1	
	Signal +	Blue	2	
	Excitation -/ Signal -	White	3	
Models	Lead	Color	4 PIN	
Output:4-20mA Hirschmann DIN43650 3000 Series	Excitation +/ Signal +	Red	1	
	Excitation -/ Signal -	Black	2	
Models	Lead	Color	4PIN	
Output: 0-5V; 0-10V M12 ^ 1 3000 Series	Excitation +	Red	1	
	Signal +	Blue	3	
	Excitation -/ Signal -	White	4	
Models	Lead	Color	4 PIN	
Output: 4-20mA M12 • 1 3000 Series	Excitation +/ Signal +	Red	1	
	Excitation -/ Signal -	Black	3	
Models	Lead	Color		
Output: 0-5V; 0-10V Cable 3000 Series	Signal +	Blue		
	Signal -	Green/White		
	Excitation +	Red		
	Excitation -	Yellow		
Models	Lead	Color		
Output: 4-20mA Cable 3000 Series	Excitation +/ Signal +	Red		
	Excitation -/ Signal -	Black		